



INTAKE SYSTEMS

Installation Instructions
Part Number 311-212
2011-12 Dodge Durango
2011-12 Jeep Grand Cherokee
5.7L and 3.6L

Packing List:

#1	701-539	Airaid Premium Filter	1
#2	KIT212RPC	Rear Panel	1
#3	KIT212FPC	Front Panel	1
#4	KITWSTRIP02	Weather Strip 22"	1
#5	KITHOSE01	1/2"x13" Breather Hose	1
	KIT212HPS	Hardware & Instructions	1
#6	KIT212B	Mounting Bracket	1
#7	KITELBOW04	1/2"x90deg. Elbow	1
#8	KIT15DHC3050	1/4-20 Button Head Bolt	2
#9	KIT09FWZ019	1/4" Flat Washer	2
#10	KIT1420WZZF	1/4-20 Flange nut	2
#11	KIT11TCPPCZ016	8-32 Thread Cutting Screw	10
#12	KITBMP03	Rubber Bumper	1

Tools Required For Installation:

5/32" Allen Wrench
 5/16", 10 and 13mm Sockets
 Ratchet & Extension, Pliers, and
 Standard and Phillips Head Screwdrivers

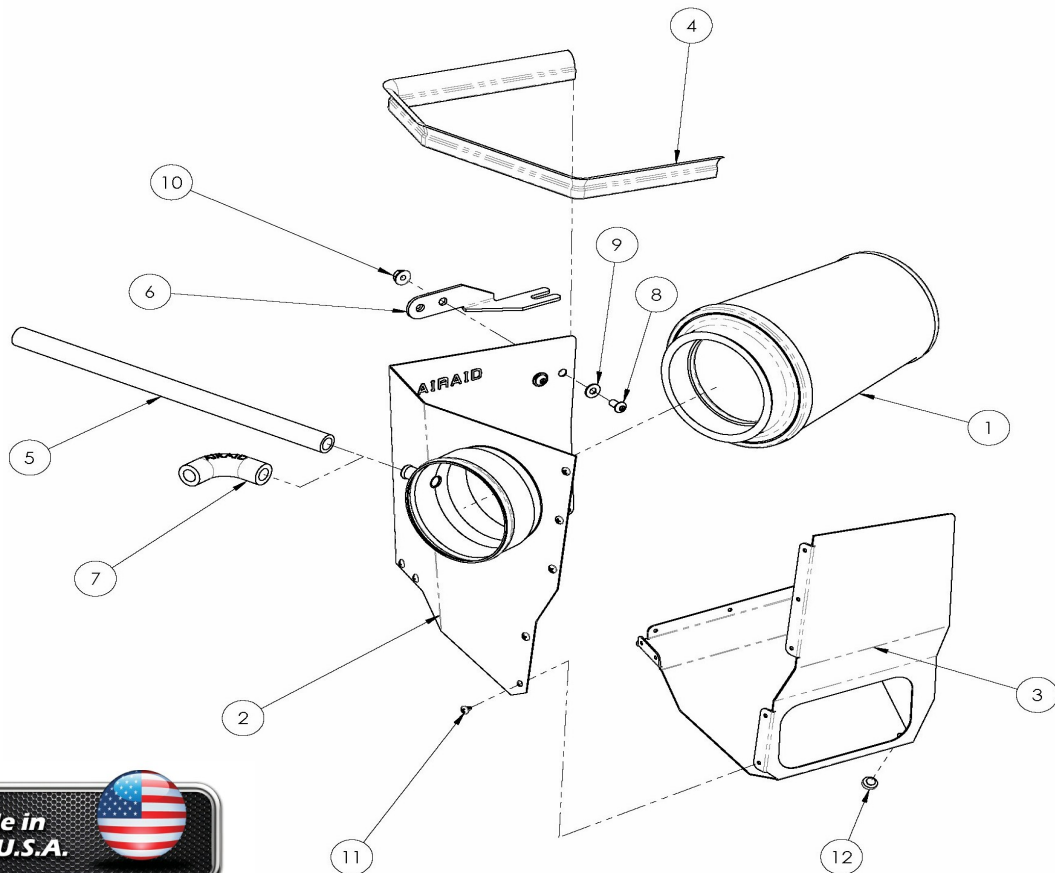

NOTE: These instructions depict an installation being performed on a Jeep Grand Cherokee 5.7L and is meant to be a guide for all other makes and models listed. While some details may vary from vehicle to vehicle, the general install procedure remains the same.



Disconnect The Negative Battery Terminal!

1. Remove the engine cover.

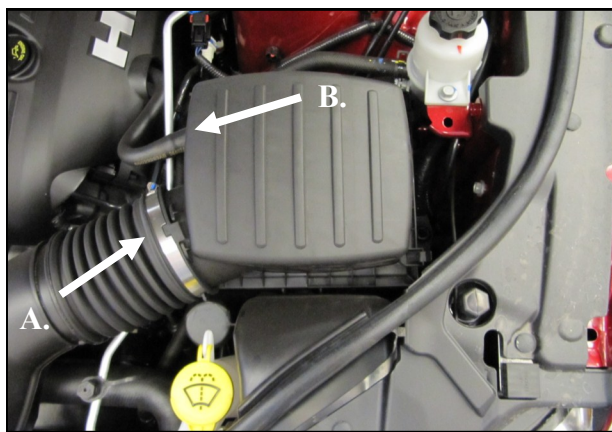

2. A) Loosen the hose clamp on the airbox side of the factory intake tube. B) Disconnect the crankcase breather line from the airbox lid.

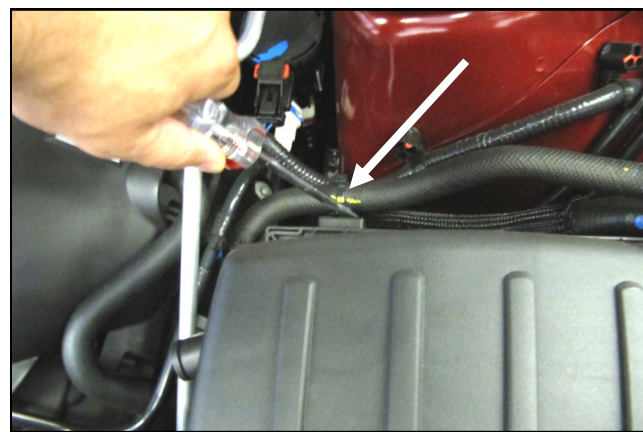

3. Using a standard head screwdriver, carefully pry and separate the hose anchor from the airbox lid. This anchor will be reused on the Airaid Intake System.

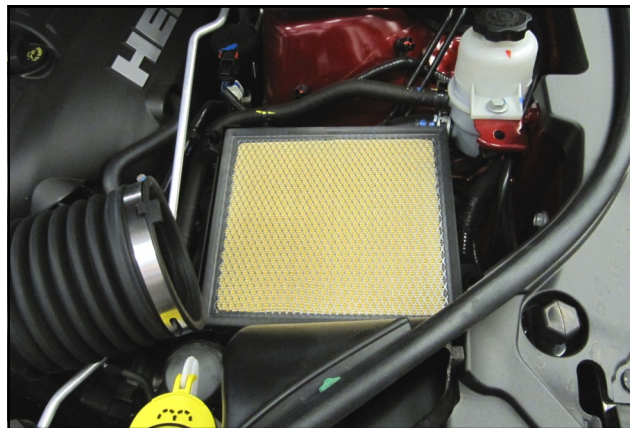

4. Remove the upper half of the airbox and the factory air filter.

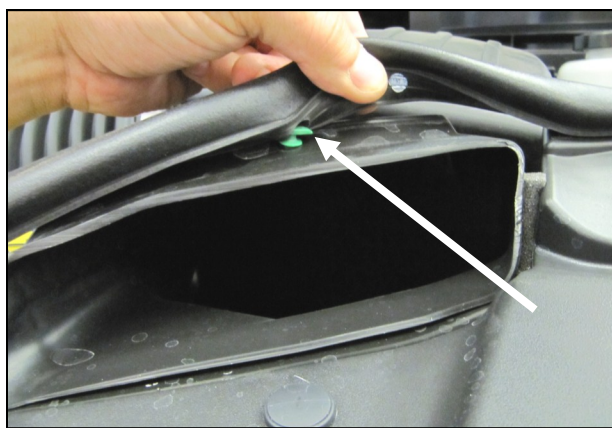

5. Carefully separate the hood seal from the cleat on the airbox inlet. Pull gently from side to side to avoid tearing the seal.

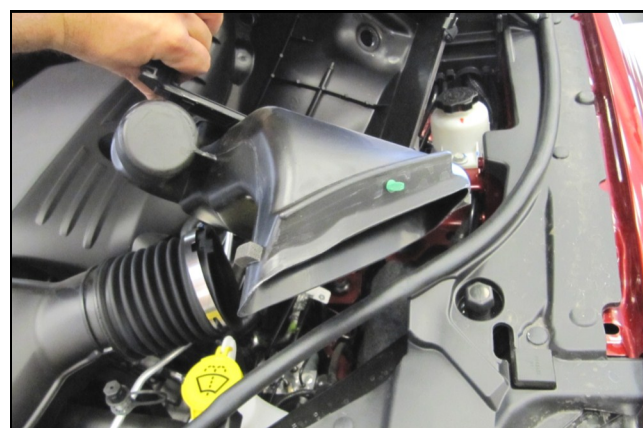

6. Unseat the lower half of the factory airbox from its mounting grommets and remove the airbox and air inlet duct as an assembly.

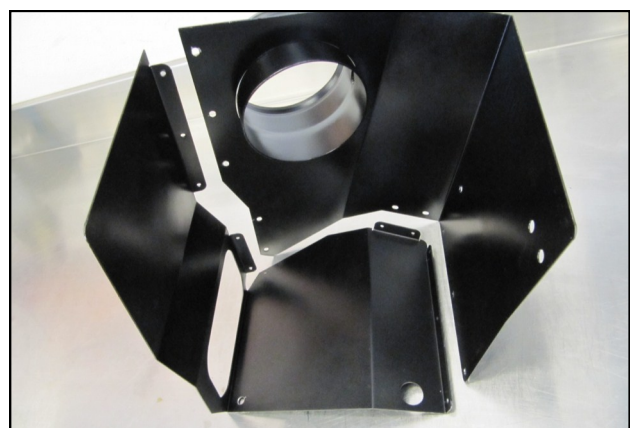

7. Fit the Front and Rear Panels (#2 and #3) together as shown with the tabs on the inside.

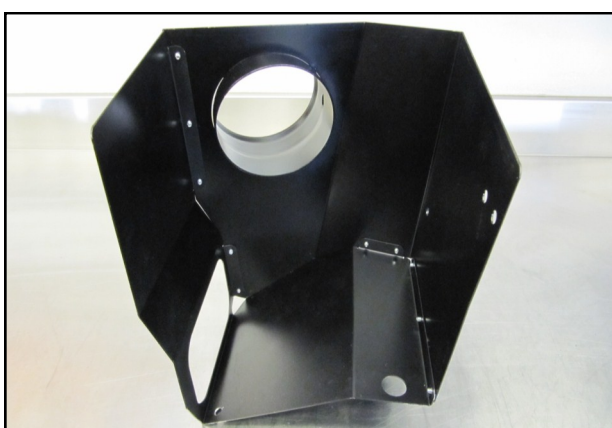

8. Join the Panels together using the ten, 8-32 Thread Cutting Screws (#11).

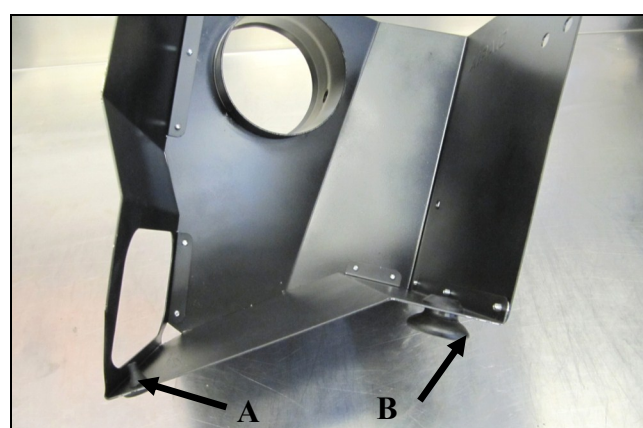

9. A.) Install the Rubber bumper (#12) into the small hole in the panel assembly.
 B.) Transfer one of the factory airbox grommets into the large hole in the Panel as shown.

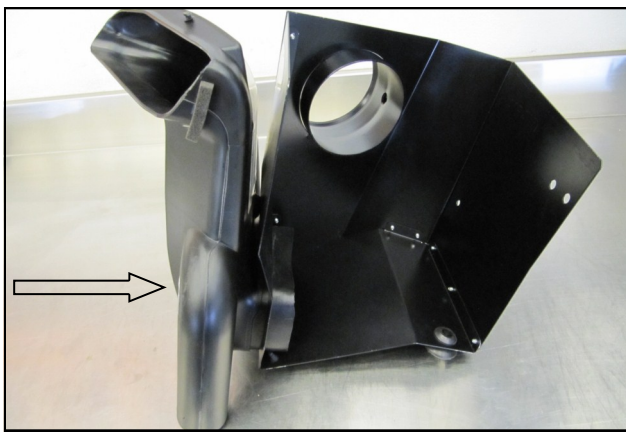

10. Transfer the factory air inlet from the airbox and into the Panel assembly.

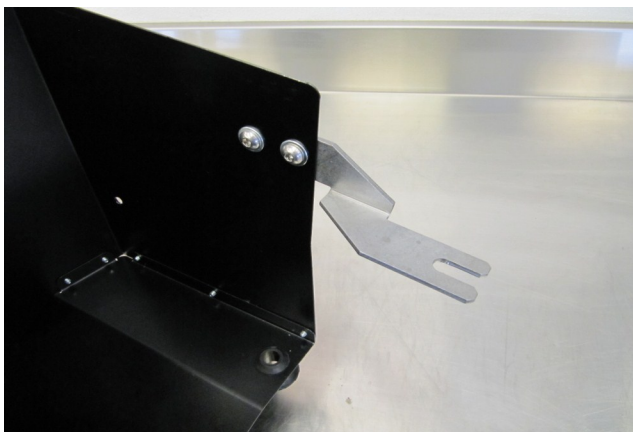

11. Install the Mounting Bracket (#6) onto the Panel assembly using the two 1/4-20 Button Head Bolts (#8), 1/4" Flat Washers (#9), and 1/4-20 Flange nuts (#10).



12. Remove the bolt securing the power steering reservoir and set it aside. This bolt will be reused in step 13. to hold the Mounting bracket.

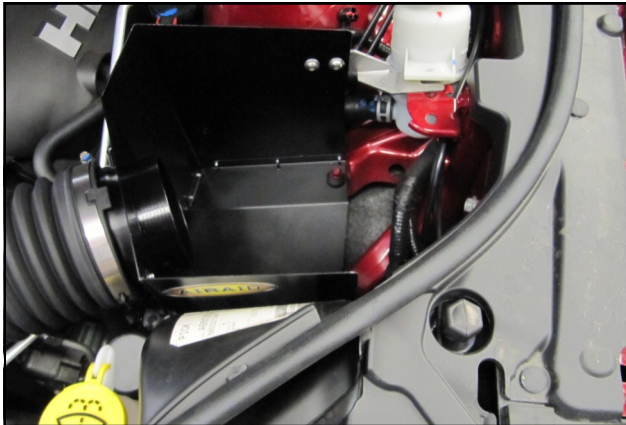

13. Install the Panel assembly into the engine compartment as shown. Slide the Mounting bracket underneath the power steering reservoir and the airbox mounting post through the grommet in the Panel. Secure the assembly by reusing the bolt from step 12. Connect the factory intake tube to the Airaid Intake tube and tighten the clamp.

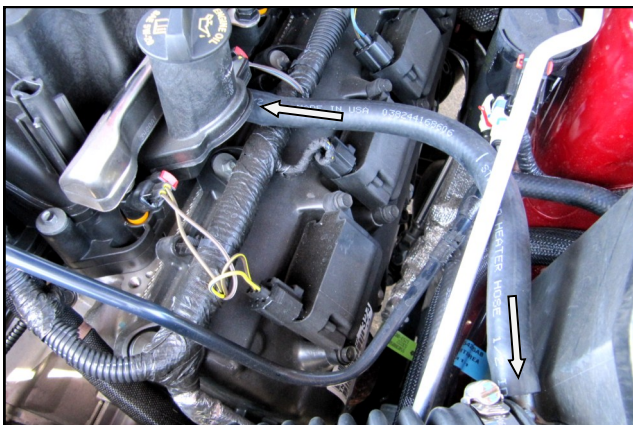

14. On V8 motors, replace the factory crankcase breather line with the 13" Breather Hose (#5) and connect it to the Airaid Intake Tube. Disregard the 90 deg. Elbow (#7) it will not be used.

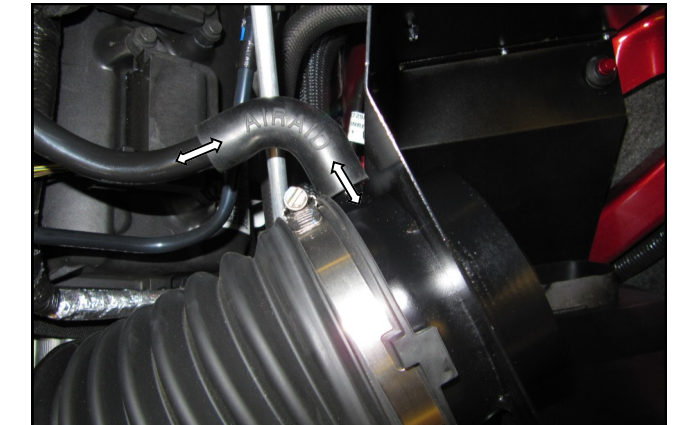

15. On V6 motors, connect the factory crankcase breather hard line to the Airaid Intake Tube using the 90 deg. Breather Elbow (#7). Disregard the 13" Breather Hose (#6) it will not be used.



16. Install the Weather Strip (#4) to the top edge of the panels, and reattach the hood seal.



17. Install the Airaid Premium Filter.

16. Double check your work!

Make sure there is no foreign material in the intake path. Make sure all clamps, hoses, bolts, and screws are tight. Double check the hood clearance!

Reconnect the negative battery cable!

SynthaMax[®]

Do Not Oil

Synthamax Air Filters do not require oil. Service air filter as needed by cleaning with common non-petroleum all-purpose household cleaner and water. Simple Green[®], Formula 409[®] or equivalent works great. Apply cleaner to outside of air filter and allow to soak. Then flush filter clean from the inside out with a garden hose and repeat steps if necessary. Do not apply high pressure water or air to clean filter. Allow filter to air dry and reinstall.

Before!



After!



Thank you for purchasing the Airaid Intake System. Contact Airaid @ (800) 498-6951 8:00 AM - 5:00 PM MST weekdays for questions regarding fit or instructions that are not clear to you. Your Airaid Intake System was carefully inspected and packaged. Check that no parts are missing, or were damaged during shipping. If any parts are missing, contact Airaid. The air filter element is protected from direct exposure to water and debris; care should be taken not to drive through deep water. WATER INGESTION IS THE DRIVERS RESPONSIBILITY! The air filter is reusable and should be cleaned using the Airaid Filter Tune-Up Kit periodically.